

4LEAN

4Lean
System

XROLLS

4LeAn
Accessories

XCasters

XPANNELS



VISUAL
Management

Lean
Office

4SAFETY

XONTAINERS



Vol. XIII

We Build Lean

Index

| Índice | Indice | Índice | Index

■ Volume 13

- [Types of Material](#)
- [4Lean System](#)
- [XRolls](#)
- [4Lean Accessories](#)
- [Xcasters](#)
- [Xpanels](#)
- [Visual Management](#)
- [Lean Office](#)
- [4Safety](#)
- [XContainers](#)

About us

4Lean is a company dedicated to the creation and implementation of Lean solutions. We have a vast knowledge in Lean, we are able to implement a full supply chain with our vast portfolio that is developed in our Lean Lab.

All organization practice Lean everyday. We have regular training in Lean and we participate in Kaizen Events to understand customer needs.

We believe our *gemba* is at customer site, we are a natural extension of your organization.

4Lean é uma empresa dedicada à criação e implementação de soluções Lean. Temos um vasto conhecimento em Lean, somos capazes de implementar uma cadeia de fornecimento completa com o nosso vasto portfólio que é desenvolvido no nosso Laboratório Lean.

Todos na organização praticam Lean diariamente. Temos uma formação regular em Lean e participamos em eventos Kaizen para entender as necessidades dos clientes.

Acreditamos que o nosso *gemba* está à vista do cliente, somos uma extensão natural da sua organização.

4Lean è una società dedicata alla creazione e implementazione di soluzioni di Lean. Abbiamo una vasta conoscenza in Lean e siamo in grado di implementare una catena di approvvigionamento grazie alla nostra vasta gamma sviluppata nel nostro Lean Lab.

Tutta la nostra organizzazione, pratica Lean tutti i giorni. Abbiamo formazione regolare in Lean e partecipiamo a cantieri Kaizen, eventi per capire al meglio i nostri clienti.

Crediamo che il nostro *gemba* è presso il cliente, siamo una naturale estensione della vostra organizzazione.

4Lean es una empresa dedicada a la creación e implementación de soluciones de Lean. Contamos con un amplio conocimiento en Lean, somos capaces de implementar una cadena de suministro completa con nuestro amplio catálogo que se desarrolla en nuestro Laboratorio de Lean.

Todos en la organización practicamos Lean diariamente. Tenemos una formación regular en Lean y participamos en Kaizen Eventos para entender las necesidades del cliente.

Creemos que nuestra *gemba* está en el sitio del cliente, somos una extensión natural de su organización.

4Lean est une société dédiée à la création et la mise en œuvre de solutions Lean. Nous avons une vaste connaissance dans Lean, nous sommes capable de construire une chaîne d'approvisionnement complète avec notre vaste portefeuille qui est développée dans notre Lean Lab.

Tout l'organisation pratique Lean quotidienne. Nous avons régulièrement des formations Lean, nous participons à chantier Kaizen pour comprendre les besoins des clients.

Nous croyons que notre *gemba* est le site du client, nous sommes un prolongement naturel de votre organisation

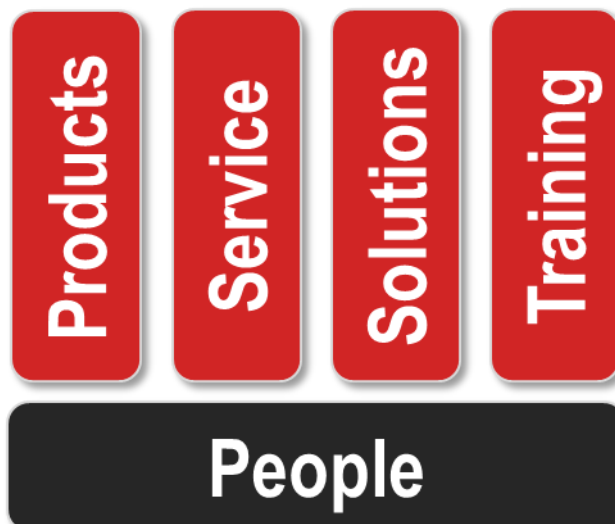

We Build Lean !

Types of Material

Conductive materials- Conductive materials have resistivities less than $10^4\Omega$ and are classified as anti-static.

Dissipative materials- Dissipative materials have resistivities lower than $10^{11}\Omega$ but greater $10^4\Omega$, "are classified as anti-static and in this range lies the ideal range for ESD materials.

Insulating Materials- Insulating materials have high electrical resistance and static charges remain on the material for a very long time. These materials are classified as not anti-static.

Anti static- The term used for materials that do not accumulate static electricity, among which conductive and dissipative materials are dominated as anti-static. No insulating materials.

Materiais condutivos- Materiais condutivos têm uma resistividades menor que $10^4\Omega$ e são classificados com anti estáticos.

Materiais dissipativos- Materiais dissipativos têm uma resistividades menor que $10^{11}\Omega$ mas maior $10^4\Omega$, são classificados com anti estáticos e nesse intervalo encontra-se a faixa ideal para materiais ESD.

Materiais Isolantes- Os materiais isolantes têm uma elevada resistência elétrica e as cargas estáticas permanecem no material por um período muito longo. Estes materiais são classificados como não anti estáticos.

Anti estático- Termo usado para materiais que não acumulam eletricidade estática, entre os quais os materiais condutivos e dissipativos se dominam com anti estáticos. Materiais isolante não.

Materiali conduttivi- I materiali conduttivi hanno resistività inferiori a $10^4\Omega$ e sono classificati come antistatici.

Materiali dissipativi- I materiali dissipativi hanno resistività inferiori a $10^{11}\Omega$ ma superiori a $10^4\Omega$, sono classificati come antistatici e in questo intervallo si trova l'intervallo ideale per i materiali ESD.

Materiali Isolanti- I materiali isolanti hanno un'elevata resistenza elettrica e le cariche statiche rimangono sul materiale per molto tempo. Questi materiali sono classificati come non antistatici.

Antistatico- Termine utilizzato per materiali che non accumulano elettricità statica, tra i quali prevalgono i materiali conduttivi e dissipativi come antistatici. Nessun materiale isolante.

Materiales conductores- Los materiales conductores tienen una resistividad inferior a $10^4\Omega$ y están clasificados como antiestáticos.

Materiales dissipativos- Los materiales disipativos tienen resistividades inferiores a $10^{11}\Omega$ pero superiores a $10^4\Omega$, se clasifican como antiestáticos y en este rango se encuentra el rango ideal para materiales ESD.

Materiales aislantes- Los materiales aislantes tienen una alta resistencia eléctrica y las cargas estáticas permanecen en el material durante mucho tiempo. Estos materiales están clasificados como no antiestáticos.

Anti estático- Término utilizado para los materiales que no acumulan electricidad estática, entre los cuales predominan los materiales conductores y disipadores, los antiestáticos. Sin materiales aislantes.

Matériaux conducteurs- Les matériaux conducteurs ont des résistivités inférieures à $10^4\Omega$ et sont classés comme antistatiques.

Matériaux dissipatifs- Les matériaux dissipatifs ont des résistivités inférieures à $10^{11}\Omega$ mais supérieures à $10^4\Omega$, sont classés comme antistatiques et dans cette plage se trouve la plage idéale pour les matériaux ESD.

Matériaux isolants- Les matériaux isolants ont une résistance électrique élevée et les charges statiques restent très longtemps sur le matériau. Ces matériaux sont classés comme non antistatiques.

Antistatique- Terme utilisé pour désigner les matériaux qui n'accumulent pas d'électricité statique, parmi lesquels les matériaux conducteurs et dissipatifs sont dominés par l'antistatique. Pas de matériaux isolants.

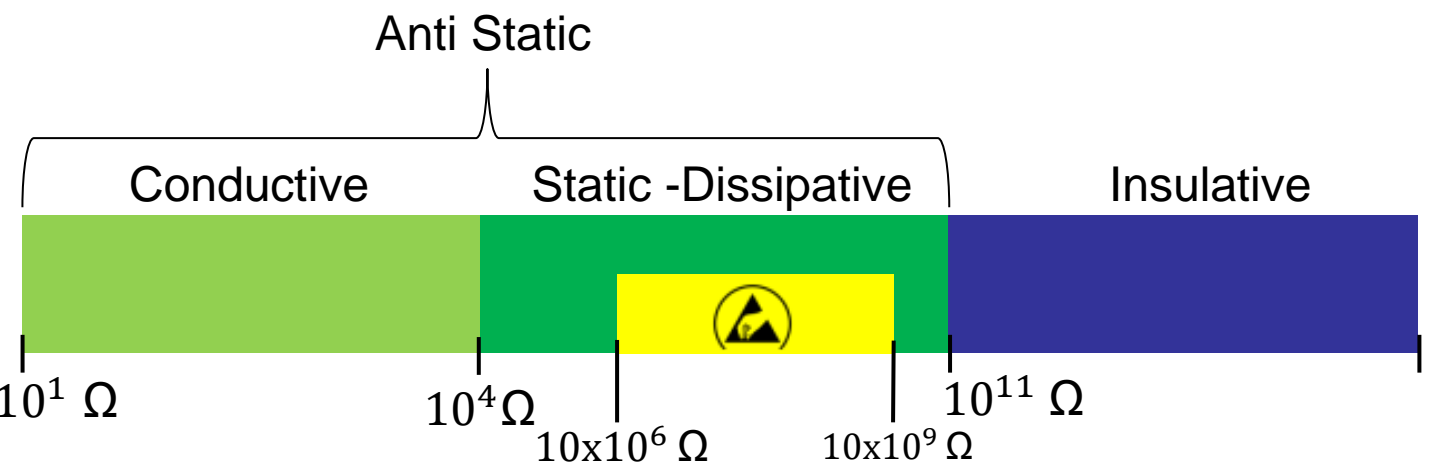



4Lean System





Pipes

|Tubos | Tubi | Tubos | Tubes

Type Tipo/Tipo Tipo/Type	Reference Referência/Articolo Referencia/Référence	Diameter Diâmetro/Diámetro Diámetro /Diamètre	Description Descrição/Descrizione Descripción/Description	Colours Cores/Colori Colores/Couleur	RAL RAL/RAL RAL/RAL	Length Comprimento / Lunghezza / Longitud / Longueur
	T-2820ESD <10° Ohms 	Ø28*2.0mm	Pipe ESD Tubo ESD/Tubi ESD/Tubo ESD/Tube ESD	Black Preto/Nero Negro	RAL 9004	4m

Pipes [2m]

| Tubos [2] | Tubi [2] | Tubos [2] | Tubes [2]

Type Tipo/Tipo Tipo/Type	Reference Referência/Articolo Referencia/Référence	Diameter Diâmetro/Diámetro Diámetro /Diamètre	Description Descrição/Descrizione Descripción/Description	Colours Cores/Colori Colores/Couleur	RAL RAL/RAL RAL/RAL	Length Comprimento / Lunghezza / Longitud / Longueur
	T-2820ESD2 * <10° Ohms 	Ø28*2.0mm	Pipe ESD Tubo ESD/Tubi ESD/Tubo ESD/Tube ESD	Black Preto/Nero Negro	RAL 9004	2m

* 2m pipe can only be purchased even quantity | Tubo a 2m só pode ser comprado quantidade par | Il tubo da 2 m può essere acquistato solo in quantità pari | La tubería de 2 m solo se puede comprar en cantidad uniforme | Le tuyau de 2 m ne peut être acheté qu'en quantité égale

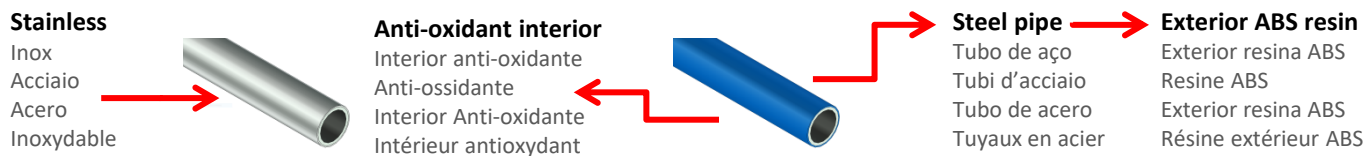



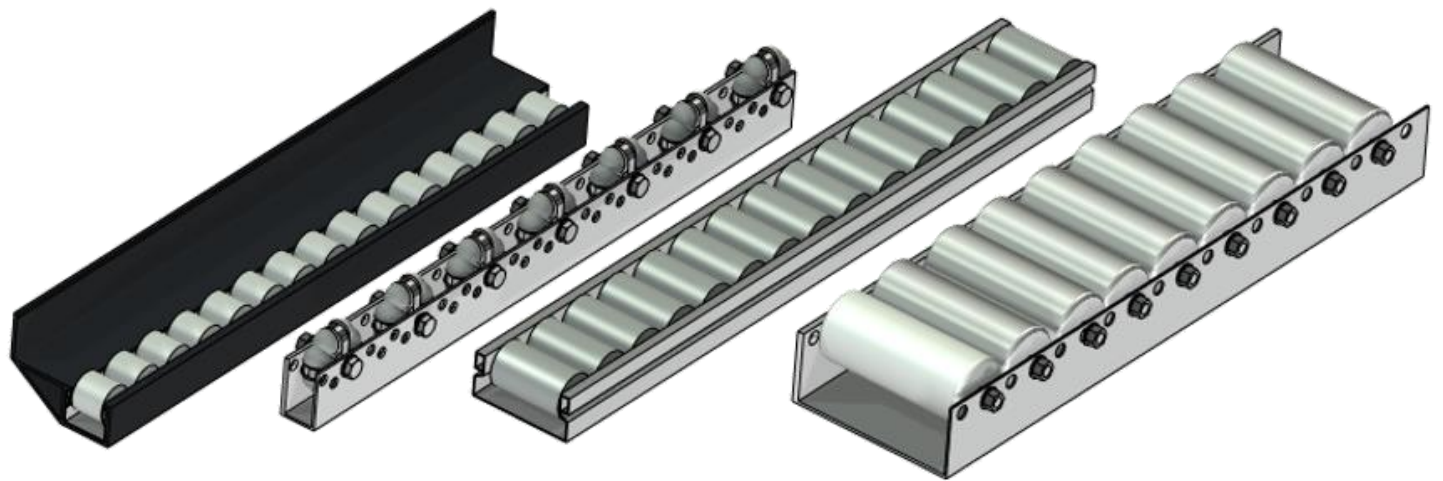

XR ROLLS





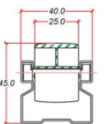

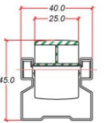
Rollers

| Rolos | Rulli | Rodillos | Rouleaux |

Type Tipo/Tipo Tipo/Type	Reference Referência/ Articolo/ Referencia/ Référence	Dimensions Dimensões/ Dimensioni/ Dimensiones/ Dimensions	Description Descrição/Descrizione Descripción/Description	Diameter Diâmetro/Diametro Diámetro/Diamètre	Roller Pitch Passo/ Passo paso/ Étape	Length Comprimento/ Lunghezza/ Longitud/ Longueur
	R-35ESD 		Roller Tracks ESD 35mm galvanized Rolos ESD 35mm galvanizado Rulli ESD 35mm zincato Rodillos ESD 35mm galvanizado Rouleaux ESD 35mm galvanisé	28 mm	33 mm	4m
	R-40ESD 		Roller Tracks ESD 40mm galvanized Rolos ESD 40mm galvanizado Rulli ESD 40mm zincato Rodillos ESD 40mm galvanizado Rouleaux ESD 40mm galvanisé	34 mm	37,5 mm	4m

Rollers [2m]

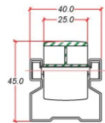
| Rolos [2m] | Rulli [2m] | Rodillos [2m] | Rouleaux [2m] |

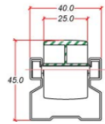
Type Tipo/Tipo Tipo/Type	Reference Referência/ Articolo/ Referencia/ Référence	Dimensions Dimensões/ Dimensioni/ Dimensiones/ Dimensions	Description Descrição/Descrizione Descripción/Description	Diameter Diâmetro/Diametro Diámetro/Diamètre	Roller Pitch Passo/ Passo paso/ Étape	Length Comprimento/ Lunghezza/ Longitud/ Longueur
	R-35ESD2 * 		Roller Tracks ESD 35mm galvanized Rolos ESD 35mm galvanizado Rulli ESD 35mm zincato Rodillos ESD 35mm galvanizado Rouleaux ESD 35mm galvanisé	28 mm	33 mm	2m**
	R-40ESD2 * 		Roller Tracks ESD 40mm galvanized Rolos ESD 40mm galvanizado Rulli ESD 40mm zincato Rodillos ESD 40mm galvanizado Rouleaux ESD 40mm galvanisé	34 mm	37,5 mm	2m**

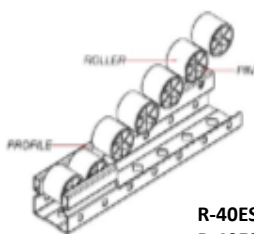

R-40ESD
R-40ESD2*













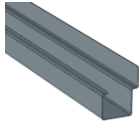

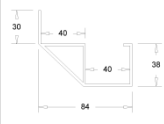
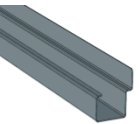
* 2m rollers can only be purchased even quantity | Rolos a 2m só pode ser comprado quantidade par | Il rulli da 2 m può essere acquistato solo in quantità pari | Rodillos de 2 m solo se puede comprar en cantidad uniforme | Le patin à roulettes de 2 m ne peut être acheté qu'en quantité égale

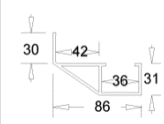
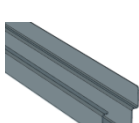
** Measures tolerance of ± 5 mm | Tolerância de ± 5 mm | Tolleranza ± 5 mm | ± 5 mm de tolerancia |

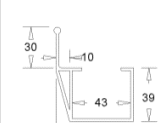
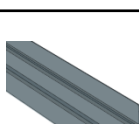

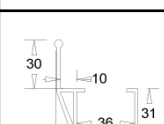
Metal guides for rollers

| Guia metal rolos | Guida di lamiera rulli | Guía de metal rodillos |



Type Tipo/Tipo Tipo/Type	Reference Referência/ Articolo/ Referencia/ Référence	Dimensions Dimensões/ Dimensioni/ Dimensiones/ Dimensions	Description Descrição/Descrizione Descripción/Description	Diameter Diamêtro/Diametro Diámetro/Diamètre	Roller Pitch Passo/ Passo paso/ Étape	Length Comprimento/ Lunghezza/ Longitud/ Longueur
	C-404M 		Flame Box Guide Roller Tracks 40mm Guia metal rolos 40mm preto Guida di lamiera rulli 40mm nero Guía de metal rodillos 40mm negro Guide boîte en métal rouleaux 40mm	-	-	1,5m
	C-354M 		Metal Guide Roller Tracks 35mm Guia metal rolos 35mm preto Guida di lamiera rulli 35mm nero Guía de metal rodillos 35mm negro Guide boîte en métal rouleaux 35mm	-	-	1,5m
	C-401M 		Metal Guide Roller Tracks 40mm (10mm flap) Guia metal rolos 40mm Guida di lamiera rulli 40mm Guía de metal rodillos 40mm Guide boîte en métal rouleaux 40mm	-	-	1,5m
	C-351M 		Metal Guide Roller Tracks 35mm (10mm flap) Guia metal rolos 35mm Guida di lamiera rulli 35mm Guía de metal rodillos 35mm Guide boîte en métal rouleaux 35mm	-	-	1,5m
	C-401AL 		Aluminium Guide Roller Tracks 40mm (10mm flap) Guia alumínio rolos 40mm Guida di alluminio rulli 40mm Guía de alumíniorodillos 40mm Guide boîte en aluminium rouleaux 40mm	-	-	4m

4Le n Accessories



ESD Retractor Balancers

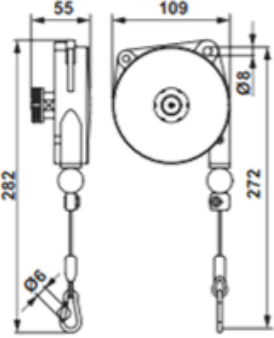

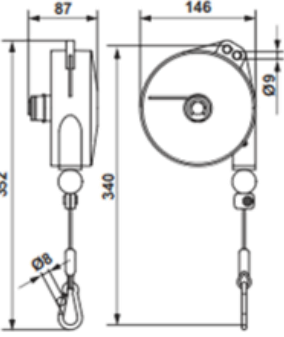
| Balanceadores retratores ESD | Bilanciatori retrattori ESD | Equilibradores de retractor ESD |
Équilibreurs d'écarteurs ESD

Product Produto Prodotto Producto Produit	Dimensions Dimensões Dimensioni Dimensiones Dimensions	Reference Referência Articolo Referencia Référence	Capacity20- Capacidade Capacità Capacidad Capacité	Net weight Peso líquido Peso netto Peso neto Poids net	Gross weight Peso bruto Peso lordo Peso bruto Poids brut	Stroke Curso Curso Distancia Gamme
 <p>→ Aluminium</p> <p>→ Inox</p>		BAL01ESD	0.2-0.5 kg	0.55 kg	0.7 kg	1600 mm
		BAL02ESD	0.4-1 kg	0.57 kg	0.7 kg	
		BAL03ESD	1-2 kg	0.6 kg	0.7 kg	
		BAL04ESD	2-3 kg	0.74 kg	0.8 kg	
 <p>→ Aluminium</p> <p>→ Inox</p>		BAL08ESD	1-2.5 kg	1,67 kg	1,9 kg	2000 mm
		BAL09ESD	2-4 kg	1,9 kg	2,1 kg	
		BAL10ESD	4-6 kg	1,98 kg	2.1 kg	
		BAL11ESD	6-8 kg	2.28 kg	2.5 kg	

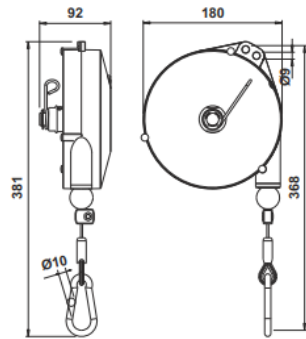

ESD Retractor Balancers

| Balanceadores retratores ESD | Bilanciatori retrattori ESD | Equilibradores de retractor ESD |
Équilibreurs d'écarteurs ESD

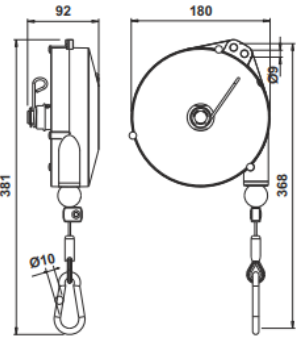
Product Produto Prodotto Producto Produit	Dimensions Dimensões Dimensioni Dimensiones Dimensions	Reference Referência Articolo Referencia Référence	Capacity20- Capacidade Capacità Capacidad Capacité	Net weight Peso líquido Peso netto Peso neto Poids net	Gross weight Peso bruto Peso lordo Peso bruto Poids brut	Stroke Curso Corso Distancia Gamme
 <p>→ Aluminium</p> <p>→ Inox</p>		BAL17LESD	0,5-2kg	3,14 kg	3.4 kg	2500 mm
		BAL17ESD	2-4 kg	3,14 kg	3.4 kg	
		BAL18ESD	4-6 kg	3.3 kg	3.6 kg	
		BAL19ESD	6-8 kg	3.36 kg	3.7 kg	
		BAL20ESD	8-10 kg	3.43 kg	3.7 kg	
		BAL21ESD	10-14 kg	3.58 kg	3.80 kg	
 <p>*</p> <p>→ Aluminium</p> <p>→ Inox</p>		BAL17SLESD	0,5-2kg	3,14 kg	3.4 kg	2500 mm
		BAL17SESD	2-4 kg	3,14 kg	3.4 kg	
		BAL18SESD	4-6 kg	3.32 kg	3.6 kg	
		BAL19SESD	6-8 kg	3.38 kg	3.7 kg	
		BAL20SESD	8-10 kg	3.48 kg	3.8 kg	
		BAL21SESD	10-14 kg	3.62 kg	3.90 kg	

*These balancers are equipped with a stop device allowing to stop the load in intermediate positions of the stroke, about every 100 mm. The stop device can be activated and deactivated at the operator's choice.



ESD Zero Gravity Balancers

| Balanceadores de gravidade zero ESD | Bilanciatori a gravità zero ESD | Equilibradores de gravedad cero ESD | Équilibreurs zéro gravité ESD

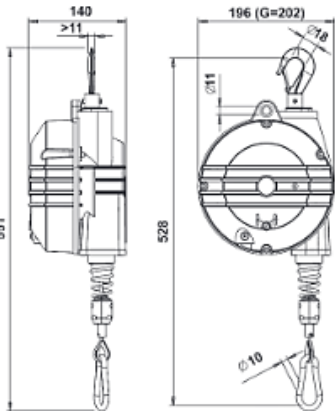
Product Produto Prodotto Producto Produit	Dimensions Dimensões Dimensioni Dimensiones Dimensions	Reference Referência Articolo Referencia Référence	Capacity20- Capacidade Capacità Capacidad Capacité	Net weight Peso líquido Peso netto Peso neto Poids net	Gross weight Peso bruto Peso lordo Peso bruto Poids brut	Stroke Curso Corso Distancia Gamme
 <p>→ Aluminium</p> <p>→ Inox</p>		BAL22ESD	4-7 kg	4.94 kg	6 kg	2000 mm
		BAL23ESD	7-10 kg	5.30 kg	6.4 kg	
		BAL24ESD	10-14 kg	5.67 kg	6.8 kg	
		BAL25ESD	14-18 kg	6.26 kg	7.4 kg	
		BAL26ESD	18-22 kg	5.89 kg	7 kg	
		BAL27ESD	22-25 kg	6.53 kg	7.6 kg	
		BAL22FESD *	4-7 kg	4.94 kg	6 kg	
		BAL23FESD *	7-10 kg	5.30 kg	6.4 kg	
		BAL24FESD *	10-14 kg	5.67 kg	6.8 kg	
		BAL25FESD *	14-18 kg	6.26 kg	7.4 kg	
		BAL26FESD *	18-22 kg	5.89 kg	7 kg	
		BAL27FESD *	22-25 kg	6.53 kg	7.6 kg	

*The ".F" version includes a brake/friction device. It is not possible to assemble such device on balancers already installed.



ESD Zero Gravity Balancers

| Balanceadores de gravidade zero ESD | Bilanciatori a gravità zero ESD | Equilibradores de gravedad cero ESD | Équilibreurs zéro gravité ESD

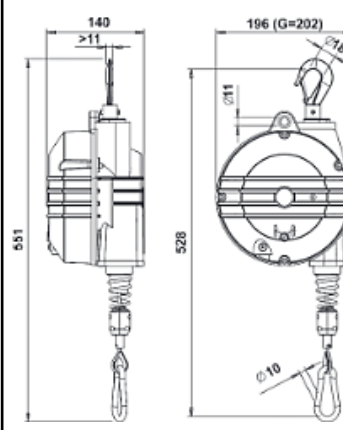
Product Produto Prodotto Producto Produit	Dimensions Dimensões Dimensioni Dimensiones Dimensions	Reference Referência Articolo Referencia Référence	Capacity20- Capacidade Capacità Capacidad Capacité	Net weight Peso líquido Peso netto Peso neto Poids net	Gross weight Peso bruto Peso lordo Peso bruto Poids brut	Stroke Curso Curso Distancia Gamme
 <p>→ Aluminium</p> <p>→ Inox</p>		BAL69ESD	20-30 kg	12.6 kg	14.4 kg	2100 mm
		BAL70ESD	30-40 kg	15.20 kg	17.0 kg	
		BAL71ESD	40-50 kg	15.50 kg	17.3 kg	
		BAL72ESD	50-60 kg	16.70 kg	18.5 kg	
		BAL73ESD	60-70 kg	15.50 kg	17.3 kg	
		BAL74ESD	70-80 kg	17.70 kg	19.5 kg	
		BAL75ESD	80-90 kg	16.20 kg	18.0 kg	
		BAL76ESD	90-100 kg	16.80 kg	18.6 kg	
		BAL69FESD *	20-30 kg	12.6 kg	14.4 kg	
		BAL70FESD *	30-40 kg	15.20 kg	17.0 kg	
		BAL71FESD *	40-50 kg	15.50 kg	17.3 kg	
		BAL72FESD *	50-60 kg	16.70 kg	18.5 kg	
		BAL73FESD *	60-70 kg	15.50 kg	17.3 kg	
		BAL74FESD *	70-80 kg	17.70 kg	19.5 kg	
		BAL75FESD *	80-90 kg	16.20 kg	18.0 kg	
		BAL76FESD *	90-100 kg	16.80 kg	18.6 kg	

*The ".F." version includes a brake/friction device. It is not possible to assemble such device on balancers already installed.



ESD Zero Gravity Balancers

| Balanceadores de gravidade zero ESD | Bilanciatori a gravità zero ESD | Equilibradores de gravedad cero ESD | Équilibreurs zéro gravité ESD

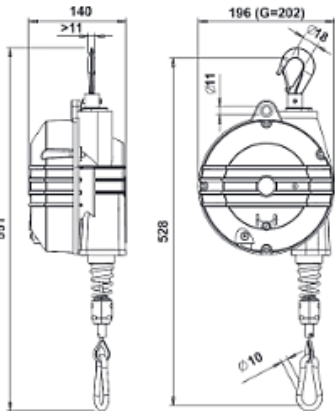
Product Produto Prodotto Producto Produit	Dimensions Dimensões Dimensioni Dimensiones Dimensions	Reference Referência Articolo Referencia Référence	Capacity20- Capacidade Capacità Capacidad Capacité	Net weight Peso líquido Peso netto Peso neto Poids net	Gross weight Peso bruto Peso lordo Peso bruto Poids brut	Stroke Curso Corso Distancia Gamme	
 <p>→ Aluminium</p> <p>→ Inox</p>		BAL77ESD	12-20 kg	12.8 kg	14.6 kg	2700 mm	
		BAL78ESD	20-30 kg	12.6 kg	14.4 kg		
		BAL79ESD	30-40 kg	15.8 kg	17.6 kg		
		BAL80ESD	40-50 kg	15.4 kg	17.2 kg		
		BAL81ESD	50-60 kg	16.6 kg	18.4 kg		
		BAL82ESD	60-70 kg	15.7 kg	17.5 kg		
		BAL77FESD	*	12-20 kg	12.8 kg		14.6 kg
		BAL78FESD	*	20-30 kg	12.6 kg		14.4 kg
		BAL79FESD	*	30-40 kg	15.8 kg		17.6 kg
		BAL80FESD	*	40-50 kg	15.4 kg		17.2 kg
		BAL81FESD	*	50-60 kg	16.6 kg		18.4 kg
		BAL82FESD	*	60-70 kg	15.7 kg		17.5 kg

*The ".F" version includes a brake/friction device. It is not possible to assemble such device on balancers already installed.



Xcasters

MORE
PRODUCTS
AVAILABLE
CONTACT US

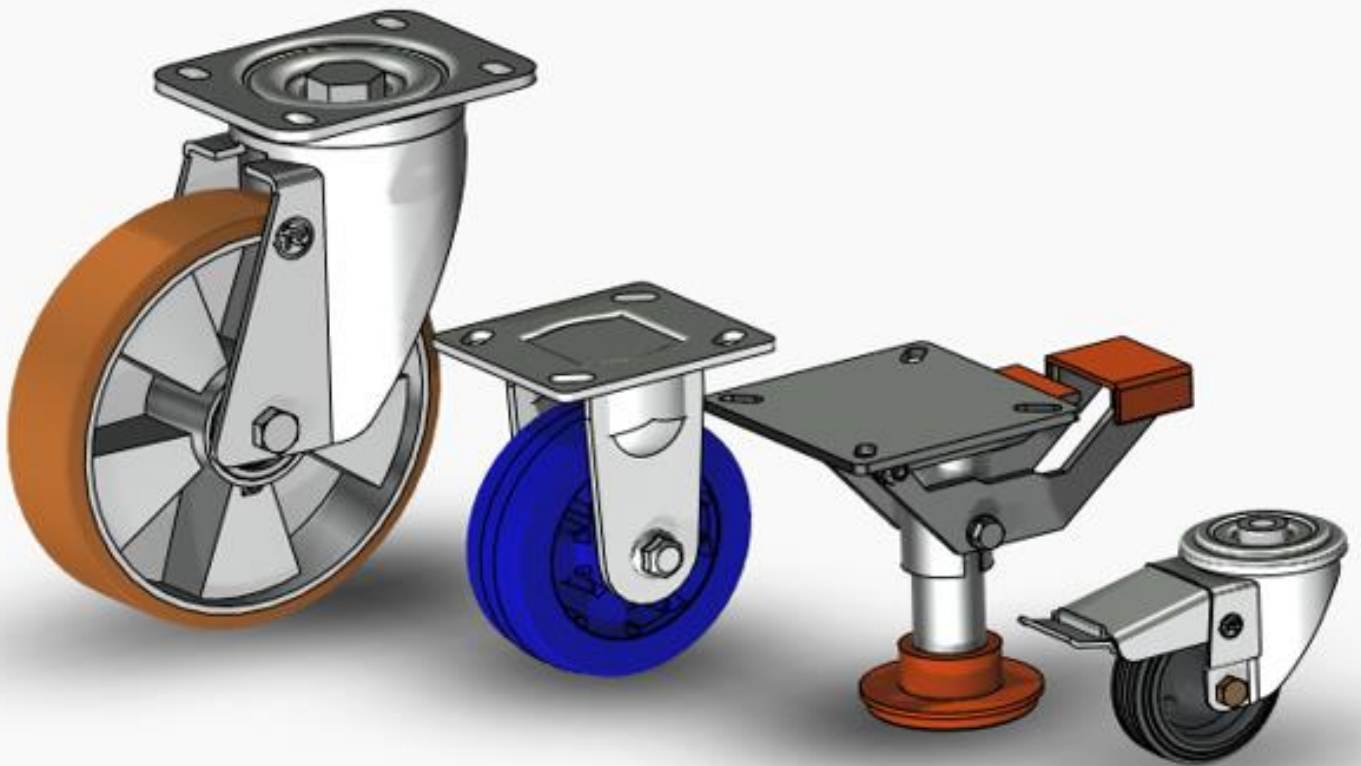

ESD Casters

| Rodízios ESD | Ruote ESD | Ruedas ESD | Roulettes ESD |

Conductive ISO22883:2004
Electric resistance < 10⁵ Ohms

Conductive ISO22883 2004
Electric resistance < 10⁹ Ohms



Type Tipo/Tipo Tipo/Type	Reference Referência/ Articolo/ Referencia/ Référence	Brake type Tipo de travão Tipo di freno Tipo de freno Type de frein					A B		A B	Kg
 R <10 ⁵ Ω	RO4-80FE	-	-	128	∅100	30	A= Rubber B= Steel	Roller Rolete / Rullo/ Rodillo / Rouleau	A=80 B=60	80
 R <10 ⁵ Ω	RO4-80RTE		∅236	128	∅100	30	A= Rubber B= Steel	Roller Rolete / Rullo/ Rodillo / Rouleau	A=80 B=60	80
 R <10 ⁵ Ω	RO4-80RT3E		∅170	128	∅100	30	A= Rubber B= Steel	Roller Rolete / Rullo/ Rodillo / Rouleau	-	80
 R <10 ⁵ Ω	RO4-80R3E	-	-	128	∅100	30	A= Rubber B= Steel	Roller Rolete / Rullo/ Rodillo / Rouleau	-	80
 R <10 ⁵ Ω	RO4-200AFE	-	-	138	∅100	30	A= Polyurethane B= Aluminium	Ball Esferas /Sfera/ Esfera / Sphère	A=76 B=46	200
 R <10 ⁵ Ω	RO4-200ARE		∅192	138	∅100	30	A= Polyurethane B= Aluminium	Ball Esferas /Sfera/ Esfera / Sphère	A=76 B=46	200
 R <10 ⁵ Ω	RO5-130FE	-	-	156	∅125	37.5	A= Rubber B= Steel	Roller Rolete / Rullo/ Rodillo / Rouleau	A=80 B=60	130
 R <10 ⁵ Ω	RO5-130RTE		∅199	156	∅125	37.5	A= Rubber B= Steel	Roller Rolete / Rullo/ Rodillo / Rouleau	A=80 B=60	130

CPE-3MRESD



Plate in use to 80kg and 130kg casters:

Placa a utilizar em rodízios de encaixe 80kg e 130kg:
Piastra da usare in 80kg e 130kg route:
Placa a usar en ruedas hasta 80kg y 130kg:
Plaque à utiliser sur roulettes ajustés 80kg et 130kg:

C-29



Bushing in use to casters with through hole (RO4-80RT3E and RO4-80R3E):

Casquillo a utilizar em rodízios com furo passante (RO4-80RT3E e RO4-80R3E):
Boccola utilizzando le rotelle foro passante (RO4-80RT3E e RO4-80R3E):
El casquillo con las ruedas con orificio passante (RO4-80RT3E y RO4-80R3E):
Douille à utiliser sur roulettes avec trous traversants (RO4-80RT3E y RO4-80R3E):

Units in mm | Unidades em mm | Unità in mm | Unidades en mm | Unités en mm





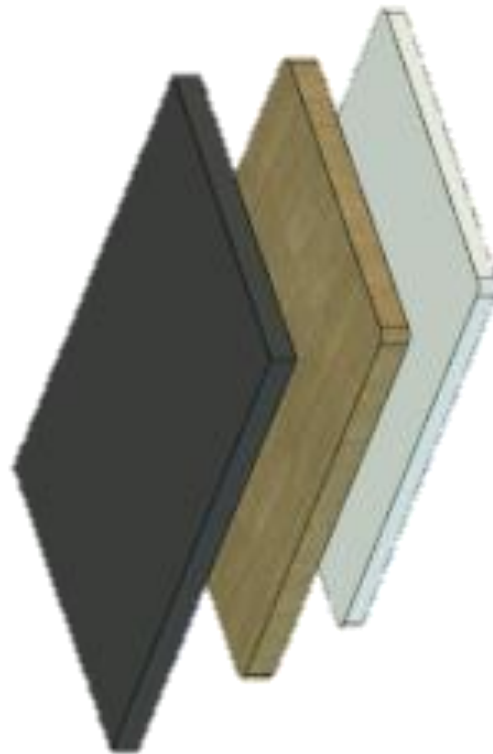



XP ANNELS

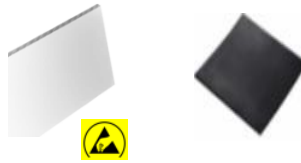

Solutions for panels

| Soluções para tampos | Soluzioni per pannelli | Soluciones para tableros | Solutions pour plateaux

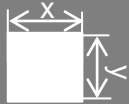

	HDF10MB	RUBESD
Material Materiale Matériel	Stratificato Print HDF HDF	 Rubber ESD Borracha ESD Gomma ESD Caucho ESD Caoutchouc ESD
	10,4	3
	Smooth Surface Laminado Laminato Laminé	Ribbed Estriado Striato Strié
Colour Cor Colore Color Couleur	B 	P 
	2850x2100 or 2100x1420**	1200x1500

The smooth surface of laminated HDF makes it easy to clean

A superfície lisa do HDF laminado facilita a sua limpeza
 La superficie liscia del HDF laminato lo rende facile da pulire
 La superficie lisa del HDF laminado permite una fácil limpieza
 La surface lisse du HDF stratifié permet un nettoyage facile

*Cut to size | Cortado á medida | Tagliato a misura | Cortado a la medda | Coupé à la taille

**Half plate has 2 holes | Meia placa tem 2 furos | Mezza piastra ha 2 fori | La mitad de la placa tiene 2 agujeros | La demi-plaque a 2 trous



VISUAL Management



FLOW

TPM

TQM



ShadowBoard

| Espuma | Schiuma | Espuma | Mousse |



Watch Now

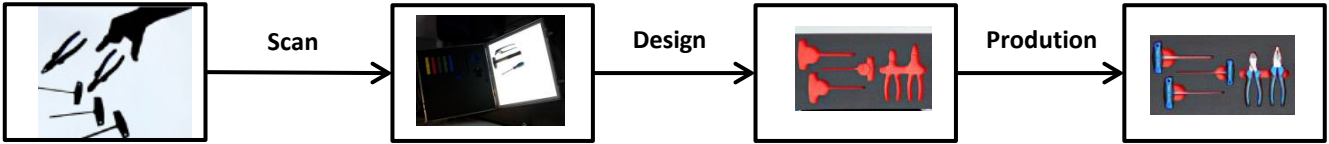

4LEAN

Shadowboard Designer



Foam

Espuma / Schiuma / Espuma / Mousse

Reference Referència/Articolo Referencia/Référence	Product Prodotto / Prodotti /Producto /Produit	Colours Cores/Colore Colori/Couleur	Thickness* Espessura / Spessore / Espesor/ Épaisseur (mm)	Specifications Especificações / Specifiche / Especificaciones / Spécifications	Applications examples Exemplos de aplicação / Esempi di applicazioni / Ejemplos de aplicaciones / Exemples d'applications
B-FMESD		P	30 60 90	Density 45kg/m3 With adhesive Densidade 28g/m3 com adesivo / Densità 28kg/m3 com adesivo / Densidad 28kg/m3 com adhesivo / Densité 28kg/m3 avec adhésif	To be used with tools Para ser usado com ferramentas / Da utilizzare con gli strumenti / Para ser utilizado con herramientas / Pour être utilisé avec des outils

Reference + Thickness + Colour

Ex.: **B-FM30A**



Lean Office



Shadow Board for office

| Espuma para escritório | Schiuma per ufficio | Espuma de oficina | Mousse pour le bureau |





Stationary

CUSTOMIZED SOLUTION



Foam

Espuma / Schiuma / Espuma / Mousse

Reference Referência/Articolo Referencia/Référence	Product Produto / Prodotti /Producto /Produit	Colours Cores/Colore Colores/Couleur	Thickness* Espessura / Spessore / Espesor/ Épaisseur (mm)	Specifications Especificações / Specifiche / Especificaciones / Spécifications	Applications examples Exemplos de aplicação / Esempli di applicazioni / Ejemplos de aplicaciones / Exemples d'applications
B-FMESD*		P 	30 60 90	Density 45kg/m3 With adhesive Densidade 28g/m3 com adesivo / Densità 28kg/m3 com adesivo / Densidad 28kg/m3 com adhesivo / Densité 28kg/m3 avec adhésif	To be used with tools Para ser usado com ferramentas / Da utilizzare con gli strumenti / Para ser utilizado con herramientas / Pour être utilisé avec des outils

***Thickness can vary according customer request**

*A espessura pode variar de acordo com o pedido do cliente

*Spessore può variare a seconda richiesta del cliente

*Espesor puede variar según la petición del cliente

*Épaisseur peut varier selon la demande du client

***If you prefer adhesive foam, you have to consider the references of the foam and the adhesive**

*Se preferir espuma adesiva, tem que ter em consideração as referências da espuma e do adesivo

* Se si preferisce schiuma adesiva, è necessario considerare i riferimenti della schiuma e l'adesivo

* Si lo prefiere espuma adhesiva, tienes que considerar las referencias de la espuma y el adhesivo

* Si vous préférez la mousse adhésive, vous devez considerer les références de la mousse et de l'adhésif



4SAFETY







Ergonomic Matting

| Tapetes Ergonómicos | Tappeti Ergonomici | Alfombras Ergonómicas | Tapis Ergonomiques|

Matting for Dry Áreas

Tapetes para áreas secas | Tappeti per superfici seche | Alfombras para zonas secas | Tapis pour les zones sèches



Reference Referência/ Articolo Referencia/ Référence	Product Produto / Prodotti /Producto /Produit	Colours Cores/Colore Colores/Couleur	Dimensions Dimensões / Dimensioni / Dimensiones / Dimensions (mm)	Thickness Espessura/Spessor e Espesor/Épaisseur	Allow Carts or trolleys	Assembly and Picking Lines	Fire Retardant	Hight Slip Prevention	Chemical and UV Resistance	Temperatu re
TEJ-P03* 		P 	1-900x650mm	14mm		X			X	Min: 5°C Max:35°C
TEJ-P04* 				14mm	X					

***Polyurethane, other sizes available**

- Poliuretano, outras dimensões disponível
- Poliuretano, altre dimensioni disponibili
- Poliuretano, otras dimensiones disponibles
- Polyuréthane, autres dimensions disponibles

Matting for Wet Areas

Tapetes para áreas húmidas | Tappeti per superfici umido | Alfombras para zonas húmedas | Tapis pour les zones humide

Reference Referência/ Articolo Referencia/ Référence	Product Produto / Prodotti /Producto /Produit	Colours Cores/Colore Colores/Couleur	Dimensions Dimensões / Dimensioni / Dimensiones / Dimensions (mm)	Thickness Espessura/S pessore Espesor/Épa isseur	Allow Carts or trolleys	Assembly and Picking Lines	Allow Mineral and Vegetable Oils	Hight Slip Prevention	Petrochem ical and Heat Resistance	Temperatur e
TEJ-B02* 		P 	1-900x600mm	13mm		X		X		Min: - 40°C Max:90° C

***Nitril Rubber, other sizes available**

- Borracha Nitrílica, outras dimensões disponível
- Gomma Nitrílica, altre dimensioni disponibili
- Caucho de Nitrilo, otras dimensiones disponibles
- Caoutchouc Nitrile, autres dimensions disponibles



Ergonomic Matting

| Tapetes Ergonómicos | Tappeti Ergonomici | Alfombras Ergonómicas | Tapis Ergonomiques|

Watch Now



Matting for Dry Áreas

Tapetes para áreas secas | Tappeti per superfici seche | Alfombras para zonas secas | Tapis pour les zones sèches

Reference Referência/ Articolo Referencia/ Réference	Product Produto / Prodotti /Producto /Produit	Colours Cores/Colore Colores/Couleur	Dimensions Dimensões / Dimensioni / Dimensiones / Dimensions (mm)	Thickness Espessura/Spessore Espesor/Épaisseur	Allow Carts or trolleys	Assembly and Picking Lines	Fire Retardant	Hight Slip Prevention	Chemical and UV Resistance	Temperature
TEJ-B11* 		P 	1-600x910 2-910x1500 3-910x3000 4-910x22800	14mm	x	x		x		Min: 5°C Max:35°C

***Polyurethane, other sizes available**

- Poliuretano, outras dimensões disponível
- Poliuretano, altre dimensioni disponibili
- Poliuretano, otras dimensiones disponibles
- Polyuréthane, autres dimensions disponibles



4SAFETY





Ergonomic Matting

| Tapetes Ergonómicos | Tappeti Ergonomici | Alfombras Ergonómicas | Tapis Ergonomiques|

Watch Now



Matting for Tables										
Tapetes para mesa Tappeti per tavolo Alfombras para mesa Tapis pour table										
Reference Referência/ Articolo Referencia/ Référence	Product Produto / Prodotti /Producto /Produit	Colours Cores/Colore Colores/Couleur	Dimensions Dimensões / Dimensioni / Dimensiones / Dimensions (mm)	Thickness Espessura/Spessor e Espesor/Épaisseur	Allow Carts or trolleys	Assembly and Picking Lines	Fire Retardant	Hight Slip Prevention	Chemical and UV Resistance	Temperatu re
TEJ-P05* 		B 	6-610 x 15000 7-762 x 15000 9-914 x 15000	2,3mm		x				Min: 5°C Max:35° C





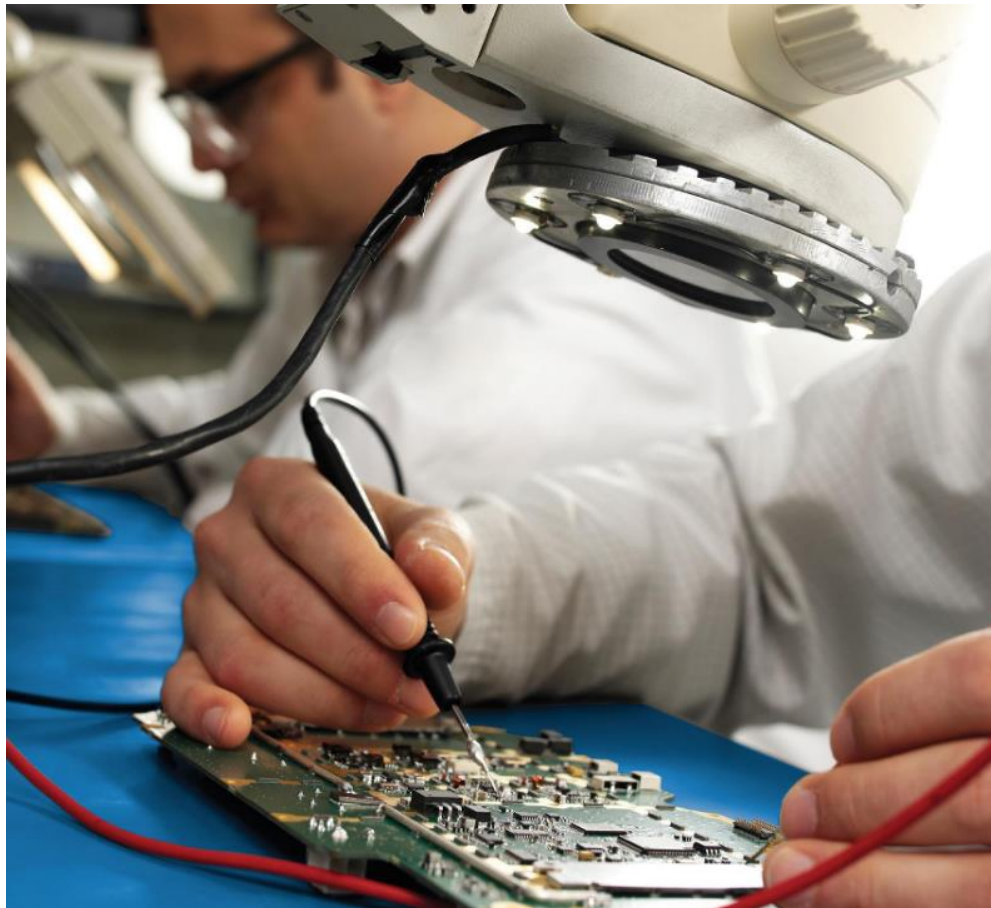

***Polyurethane, other sizes available**

- Poliuretano, outras dimensões disponível
- Poliuretano, altre dimensioni disponibili
- Poliuretano, otras dimensiones disponibles
- Polyuréthane, autres dimensions disponibles



Ergonomic Chairs

| Cadeiras Ergonómicas | Sedie Ergonomici | Sillas Ergonómicas | Chaises Ergonomiques |

Ergonomic Stool Whit ESD					
Bancos Ergonómicos Ponchi Ergonomici Bancos Ergonómicos Stool Ergonomiques					
Reference Referência/ Articolo Referencia/ Référence	Product Produto / Prodotti / Producto /Produit	Type Tipo/Tipo Tipo/Type	Gas cylinder Cilindro de gás/ Cilindro del gas/ Cilindro de gas/ Bouteille de gaz	Other data Características especiais/ Caratteristiche speciali/ Características especiales/ Special features	Max. User weight Max. Peso do Usuário/ Max. Peso utente/ Max. Peso del usuário/ Max. Poids de l'utilisateur
ESDESG-1			610 – 895		120 Kg
ESDEDG-5			630 - 840		
ESDESC-1			440 - 570		
ESDERC-1			510 - 640		

XCONTAINERS



Euro box ESD

| Eurocaixas ESD | Contenitori di plastica ESD| Eurocaja ESD | Euro boîte ESD

Eurobox ESD													
Reference Referência/ Articolo Referencia/ Référence	Handles Pegas/ Pegasi	Length (mm) Comprimento / Lunghezza / Largo / Longueur		Width (mm) Largura / Larghezza / Ancho / Largeur		Height (mm) Altura / Altezza / Altura / Hauteur		Quantity Quantidade / Cantidad / Quantité (pallet)	Colours Cores/Colore Couleurs/Couleur				
		Exterior Exterior / Esterno / Exterior / Extérieur	Interior Interior / Interno / Interior / Intérieur	Exterior Exterior / Esterno / Exterior / Extérieur	Interior Interior / Interno / Interior / Intérieur	Exterior Exterior / Esterno / Exterior / Extérieur	Interior Interior / Interno / Interior / Intérieur						
EC21-1ESD	C-Closed	200	170	150	120	120	115	760	Traffic Black similar RAL 9017				
EC32-1ESD		300	270	200	170	120	115	380					
EC32-2ESD						170	165	260					
EC43-0ESD		400	370	300	270	75	70	330					
EC43-1ESD						120	115	190					
EC43-2ESD						170	165	130					
EC43-3ESD						220	215	100					
EC43-4ESD						270	265	80					
EC43-5ESD						320	315	70					
EC64-0ESD						600	570	400		370	75	70	140
EC64-1ESD											120	115	95
EC64-2ESD		170	165	60									
EC64-3ESD		220	215	50									
EC64-4ESD		270	265	40									
EC64-5ESD		320	315	45									
EC64-6ESD		420	415	30									
EC86-1ESD		800	770	600	570						120	115	34
EC86-2ESD						220	215	20					
EC86-3ESD						320	315	12					
EC86-4ESD						420	415	10					

Compatible with CP-2.

- Compatível com CP-2.
- Compatibile con CP-2.
- Compatible con CP-2
- Compatible avec CP-2

CP-2



Boxes KLT ESD

| Caixas KLT ESD | Contenitori KLT ESD | Caja – KLT ESD| Boîte - KLT ESD|

C-KLT ESD								
Reference Referência/ Articolo Referencia/ Référence	Handles Pegas/ Pegs/ Pegues	Length (mm) Comprimento / Lunghezza / Largo / Longueur		Width (mm) Largura / Larghezza / Ancho / Largeur		Height (mm) Altura / Altezza / Altura / Hauteur		Minimum order quantity Quantidade de ordem mínima/ Quantità di ordine minimo / Cantidad mínima de pedido / Quantité d'ordre minimum (units)
		Exterior Exterior / Esterno / Exterior / Extérieur	Interior Interior / Interno / Interior / Intérieur	Exterior Exterior / Esterno / Exterior / Extérieur	Interior Interior / Interno / Interior / Intérieur	Exterior Exterior / Esterno / Exterior / Extérieur	Interior Interior / Interno / Interior / Intérieur	
C-KLT431E	C-Closed	400	346	300	265	147	109.5	160
C-KLT432E		400	346	300	256	280	242	80
C-KLT641E		600	544	400	364	147	109.5	80
C-KLT642E		600	544	400	364	280	242	40



C-KLTS ESD								
Reference Referência/ Articolo Referencia/ Référence	Handles Pegas/ Pegs/ Pegues	Length (mm) Comprimento / Lunghezza / Largo / Longueur		Width (mm) Largura / Larghezza / Ancho / Largeur		Height (mm) Altura / Altezza / Altura / Hauteur		Minimum order quantity Quantidade de ordem mínima/ Quantità di ordine minimo / Cantidad mínima de pedido / Quantité d'ordre minimum (units)
		Exterior Exterior / Esterno / Exterior / Extérieur	Interior Interior / Interno / Interior / Intérieur	Exterior Exterior / Esterno / Exterior / Extérieur	Interior Interior / Interno / Interior / Intérieur	Exterior Exterior / Esterno / Exterior / Extérieur	Interior Interior / Interno / Interior / Intérieur	
C-KLTS431E	C-Closed	400	346	300	260	147	129.5	160
C-KLTS432E		400	346	300	260	280	262	80
C-KLTS641E		600	544	400	359	147	129.5	80
C-KLTS642E		600	544	400	359	280	262	40
C-KLTS862E		800	739	600	556	210	192	20



C-KLTS containers have water drainage holes in the base and can be used for areas where liquids could be drained off.

As caixas C-KLTS têm orifícios de drenagem de água na base e podem ser usado para áreas onde os líquidos podem ser drenados.

Contenitori C-KLTS hanno fori di drenaggio acqua nella base e può essere utilizzato in aree in cui il liquido può essere drenato.

Las cajas C-KLTS tienen agujeros de drenaje de agua en la base y se pueden usar para áreas en las que el líquido puede ser drenado.

Les boîtes C-KLTS ont des trous de drainage de l'eau dans le fond et peuvent être utilisés dans des zones où le liquide peut être drainé.



UK **4LEAN**

DE **4LEAN**

Iberia **4LEAN**

4LEAN

Italy **4LEAN**



Some of our clients

| Alguns dos nossos clientes | Alcuni dei nostri clienti | Algunos de nuestros clientes |
Certains de nos clients

Horeca Equipments



Industrial and Agricultural Vehicles



Power transmission



Automotive



Aeronautics



Small Appliance



E-Commerce & Warehouse



Elevators



We Build Lean

4Lean, Lda
4lean@4lean.net
www.4lean.net

Some of our clients

| Alguns dos nossos clientes | Alcuni dei nostri clienti | Algunos de nuestros clientes |
Certains de nos clients

White goods

POLIDORO
for excellence in combustion

sisme

METEOR
SINCE 1959

Whirlpool

Electrolux

FABER

Bicycles

SRAM

Maias

Micanda
The European Bike Fundamentals.

rte

ALUBIKE

Campagnolo

LOMBARDO
LINEA VENTIL

ORBEA

Electrical

ABB

CAME

bticino

efacec

OSRAM

WESTRAFO

EFAPEL

SIEMENS

simon

Electronics

ALFA
ELETTRONICA

TE
CONNECTIVITY

flex

KEMET
a YAGEO company

CAREL

OLYMPUS

vision-box

VISHAY

US TECHNOLOGIES

CARDIOLINE

Fashion

LVMH
MOËT HENNESSY, LOUIS VUITTON

NIKE

YSL

YKK

SWATCH GROUP

BALLY

KERING

Process Industry

Nestlé

BANCO DE PORTUGAL
CIGARRILHEIRA

THE NAVIGATOR
COMPANY

Coca-Cola

thyssenkrupp

PESCANOVA

Tetra Pak

Recipharm
good for business

Ventilation and refrigeration

VERTIV

Parker

Swegon

GEBI

kide

TROX TECHNIK
The art of handling air

arneg

Keyter

WoodWorking

IKEA

ALF

BRUGNOTTO
GROUP

PIANCA

Aredo3

ernestomeda

TECNOFORM

Valcucine

Industrial Machines

+GF+
GEORG FISCHER

GEA
engineering for a better world

magic
NORTH AMERICA

BOBST

salvagnini

MEGA

FRIUL
INTAGLI

WAGNER

We Build Lean

4Lean, Lda
4lean@4lean.net
www.4lean.net

Some of our clients

| Alguns dos nossos clientes | Alcuni dei nostri clienti | Algunos de nuestros clientes |
Certains de nos clients

Services



Healthcare



Construction Components



Coachworks



HandTools



Public Sector



We Build Lean

4Lean, Lda
4lean@4lean.net
www.4lean.net